



2027 VENTANA



REFINED. SPACIOUS. INNOVATIVE.

WHY VENTANA

The 2027 Ventana gives you the freedom to go anywhere, from mountain roads to stadium parking, with lengths from 35'-43'. A welcoming interior invites you to relax, with a dinette that showcases scenic views and becomes an ideal space for evenings with friends. An optional drop-down bunk adds quick sleeping space, while Comfort Drive™ Adaptive Steering delivers a smooth ride that keeps you refreshed. Customizable exterior storage organizes all your gear, a well designed kitchen simplifies every meal, and a private bedroom suite offers a peaceful retreat at day's end.

NEW FEATURES FOR 2027

- + Xite 360 Cameras with Recording
- + Now Featuring Samsung Residential Refrigerator with Water Dispenser
- + Dovetail Cabinetry Drawers Now Standard
- + Starlink Internet System Now Standard (Subscription Required)
- + Pet Package: Includes Newmar-Branded Splash-Proof Water and Food Bowls, Exterior Leash Hook and Retractable Pet Gate (Optional)



FLOOR PLANS

6

- + Length Ranges from 35'-43'
- + Bunk Floor Plans Available

EXTERIORS

3

INTERIOR DÉCORS

3

CUSTOMIZATIONS

- + **Customization Options Include:** paint colors, fabrics, flooring, doors and cabinet fronts
- + **Kitchen and Bath Customizations:** backsplashes, sinks, plumbing fixtures, and cabinet hardware
- + **Electrical Customizations:** interior and exterior outlet placement and custom wiring runs based on preference

WHY NEWMAR

Every Newmar coach is crafted with purpose, tailored to you, and backed by unwavering support. This relentless pursuit of excellence shapes everything we do. From the precision of our engineering to the responsiveness of our service. From the innovation in our designs to the personalization that honors our customer’s vision.

PRODUCT FEATURES

STAR Foundation

Your foundation for confidence begins with stability. The exclusive STAR Foundation delivers both strength and serenity through its precisely engineered steel superstructure. Carefully welded to every luxury chassis, you'll experience a ride that's both quiet and more stable.

Residential Build

At Newmar, we craft every coach with the same proven techniques used in quality residential construction. Strong, layered sidewalls pair with precisely placed C-channel aluminum studs set 16 inches on-center, while a robust truss-built roof protects your investment for the long haul. Inside, premium flooring adds stability and comfort, and durable aluminum-framed windows are built to stand the test of time, coming together to deliver a coach made to last.

Comfort Drive™

The freedom of the open road deserves control that matches your confidence. Standard on every diesel pusher and luxury model, Comfort Drive™ with Passive Steer technology puts car-like handling at your fingertips—because your journey should be defined by discovery, not compromise.

Masterpiece Finish™

Every Newmar coach is finished with our Full-Paint Masterpiece Finish™, an industry-exclusive process crafted with premium BASF paints and applied entirely within our own 45,000-square-foot paint facility by skilled Newmar artisans. We were the first RV manufacturer to offer full-body paint across every model we build—a testament to our unwavering commitment to quality and our belief that your motorhome should be as beautiful on the outside as it is welcoming on the inside.



NEWMAR SERVICE

At Newmar, we deliver a seamless service experience designed to get you back out on the road as soon as possible. It's all about providing you with an uncompromising service experience from the day you take delivery of your new home on wheels.

SERVICE FEATURES

Personal Service Tech

The Newmar Service Center offers personal service technicians and the ability to camp onsite with full hookups, receive in-depth education, use private workstations, visit with other Newmar owners in our lounge, and enjoy convenient laundry facilities along with dedicated pet lounges and a pet park.

NewServ Mobile

With NewServ, our technicians come to you for routine maintenance. Services like appliance fixes, water pump maintenance, and more are available in Southern California, Arizona, and Central Florida. To schedule your appointment, call 800-731-8300.

Newgle for Product Knowledge

Explore Newgle—our free online knowledge base—packed with information straight from Newmar, as well as our component manufacturers and suppliers.

Dedicated Brand Specialists

Newmar Service Account Managers, otherwise known as Brand Specialists, provide dealer warranty service authorizations within four business hours, and ship all in-stock parts the same day, via free ground shipment. And if a part is out of stock, they'll either pull it from the production floor or order the part from the appropriate supplier immediately.



HARDWOOD CABINETRY OPTIONS

MOREL (SHOWN IN IMAGE)



FEATURES

- + Maple Hardwood Cabinet Doors in Suede or High Gloss Finish
- + Available in Five Solid Colors and Four Two-Tone Finishes
- + Concealed Cabinet Door Hinges
- + Soft-Close Cabinet Drawers
- + Dovetail Cabinetry Drawers With Full Extension Ball Bearing Guides

CABINET COLOR OPTIONS



TWO-TONE



INTERIOR DECOR OPTIONS

SAGUARO (SHOWN IN IMAGES)



Leather Furniture & Ceiling Accent

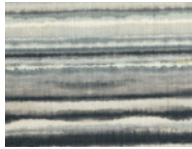

Dinette Chair & Pillows

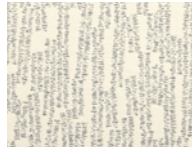

Bedspread & Bedroom Windows



Bed Pillow



Tile Flooring



Countertops

BRIGHTON



Leather Furniture & Ceiling Accent



Dinette Chair & Pillows

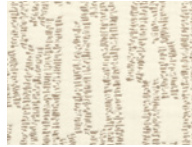

Bedspread & Bedroom Windows



Bed Pillow



Tile Flooring



Countertops

PALISADES

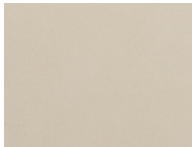

Leather Furniture & Ceiling Accent



Dinette Chair & Pillows

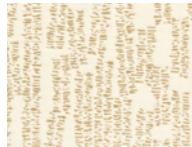

Bedspread & Bedroom Windows

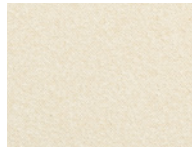

Bed Pillow



Tile Flooring

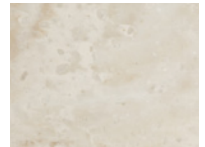

Countertops

Exterior color and interior décor options may be matched to customer preference, subject to availability. Please see your dealer for details.

EXTERIOR DESIGN OPTIONS



TIMBERVEIL

Charcoal Tweed Awning

HAVENSTONE

Charcoal Tweed Awning



EVERWOOD

Charcoal Tweed Awning



FEATURES

- + Industry-Exclusive Full-Paint Masterpiece Finish™ with Clearcoat and Cut and Buff
- + New Exterior Graphics and Colors with Three Color Combinations*

- + Ability to Customize Color Selections
- + Front Cap Diamond Shield Protection

*New for 2027

Exterior color and interior décor options may be matched to customer preference, subject to availability. Please see your dealer for details.

COCKPIT

KEY FEATURES

- + Industry-First Comfort Drive™ Adaptive Steering
- + Six-Way Power Driver and Passenger Seats
- + OnGuard™ Collision Mitigation Adaptive Cruise System with Adjustable Following Distance Control (Optional)
- + Xite Dash Radio with Apple CarPlay®, 9" Dual Monitors with Nav-N-Go Navigation System
- + Xite 360 Camera with Recording Functionality
- + Drop-Down Bunk Bed Over Driver and Passenger Seats (Optional)



POPULAR UPGRADE

- + OnGuard™ Collision Mitigation Adaptive Cruise System with Adjustable Following Distance Control

CABIN

KEY FEATURES

- + Multiple Seating Configurations Available
- + Optional Theater Seating with Adjustable Headrests Available
- + 50" Samsung® 4K LED TV on Televator
- + Porcelain Tile Flooring
- + Two 15K BTU Heat Pump Central Air Conditioners*
- + Electric Radiant Heat Beneath Main Tile Floor (Optional)
- + Starlink Internet System (Subscription Required)
- + 10" Monitor with Interior Lighting and HVAC Controls
- + Pet Package Includes: Newmar-Branded Splash-Proof Water and Food Bowls, Exterior Leash Hook and Retractable Pet Gate (Optional)**

*Three units on 43' floor plans

**New for 2027



POPULAR UPGRADE

- + Powered Theater Seating
- + Electric Radiant Heat Beneath Main Tile Floor

GALLEY & DINETTE

KEY FEATURES

- + 19.7 Cu. Ft. Whirlpool® Refrigerator
- + 22 Cu. Ft. Samsung® Refrigerator (40'+ Floor Plans)
- + All-Electric Flush Mount Induction Cooktop
- + 30" Stainless Steel Convection Microwave with Air Fryer Feature
- + Dishwasher in Drawer (Optional)
- + Central Vacuum with Tool Kit (Optional)
- + Super Polished Solid-Surface Countertops
- + Pullout Pantry Shelves
- + Dovetail Cabinetry Drawers*
- + Euro Booth Dinette* (Optional)
- + Kitchen Window (Optional)

*New for 2027



POPULAR UPGRADES

- + Dishwasher in Drawer
- + Central Vacuum with Tool Kit
- + Euro Booth Dinette
- + Kitchen Window

BEDROOM

KEY FEATURES

- + King-Size Bed with Plush Pillow-Top Mattress
- + Bunk Beds with Built-In Drawers (Floor Plan 4340)
- + Walk-In Closet with Optional Stacked Two-Piece Splendide® Washer and Dryer (Floor Plan 4345)
- + Reading Lights at Head of Bed with Dimmable and Adjustable Aim
- + Lifts on Bed Top
- + 110V Outlet in Bed Overhead with Two Pass-Through Ports
- + Samsung® 4K LED TV



POPULAR UPGRADES

- + Convert Bunk Beds to Dedicated Office Space with Desk and Chair (Floor Plan 4340)
- + Convert Bunk Beds to Wardrobe (Floor Plan 4340)
- + Convert Walk-In Closet to Bunk Beds (Floor Plan 4345)

BATHROOM

KEY FEATURES

- + Residential Shower*
- + Aqua Miser® Shower System
- + Dual Sinks on Select Floor Plans
- + Stacked Two-Piece Splendide® Washer and Dryer (Optional)
- + Super Polished Solid-Surface Countertops
- + Midship Half Baths Available on Select Floor Plans

**Shower size and style vary by floor plan*



POPULAR UPGRADE
+ Stacked Two-Piece Splendide® Washer and Dryer

EXTERIOR FEATURES

KEY FEATURES

- + Industry-Exclusive Full-Paint Masterpiece Finish™ with Clearcoat and Cut and Buff
- + Girard® G2000 Power Side Awning
- + SilverStar Ultra Headlight Bulbs
- + Exterior Entertainment Center with Samsung® 4K LED TV and Bose® Soundbar (Optional)
- + Hydraulic Smart-Level Leveling Jacks with Bluetooth Compatible Touchpad
- + 8.0 kW Cummins Onan® Diesel Generator
- + Four Flexible 120W Solar Panels on Roof (Optional)
- + 10W Solar Panel

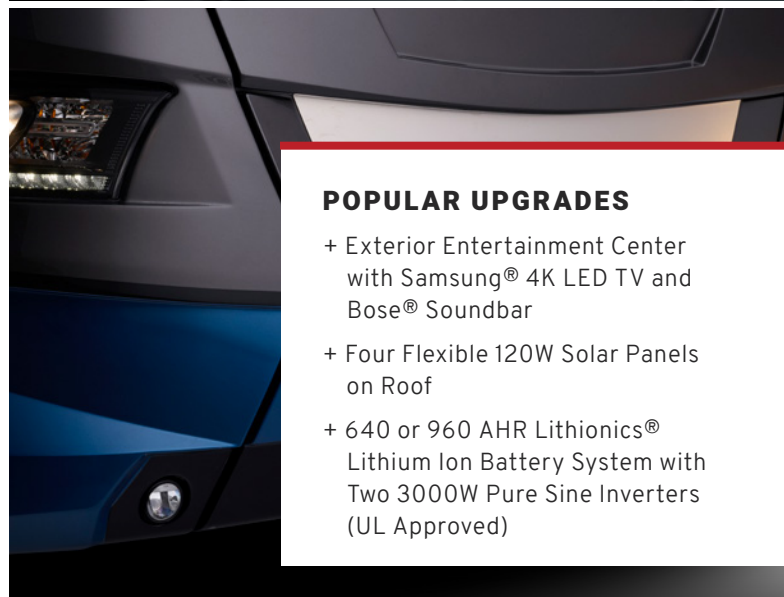

POPULAR UPGRADES

- + Exterior Entertainment Center with Samsung® 4K LED TV and Bose® Soundbar
- + Four Flexible 120W Solar Panels on Roof
- + 640 or 960 AHR Lithionics® Lithium Ion Battery System with Two 3000W Pure Sine Inverters (UL Approved)

3512 FLOOR PLAN

STANDARD

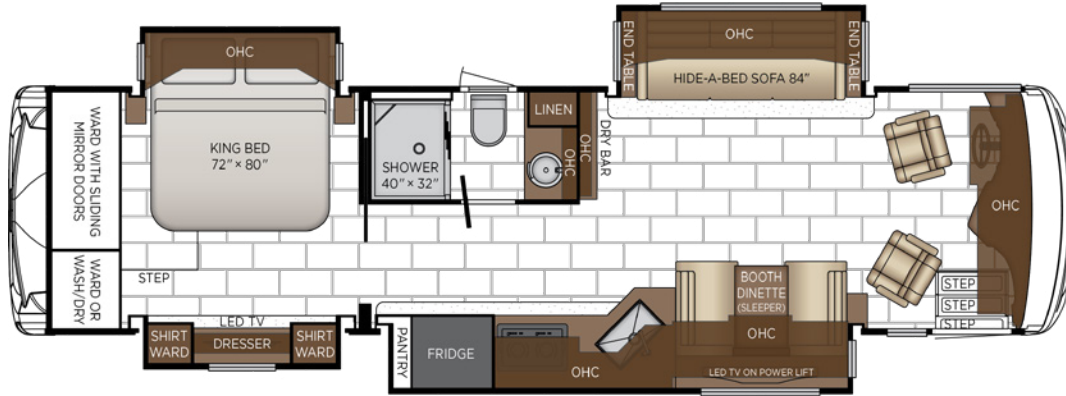

OPTIONS

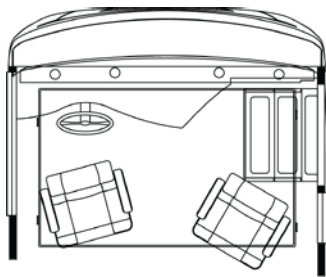

Drop Down Bunk

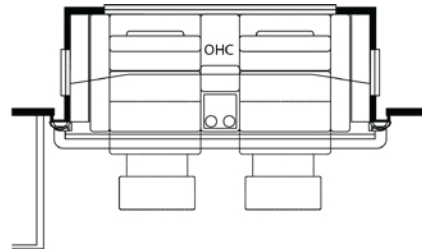

Theater Seating

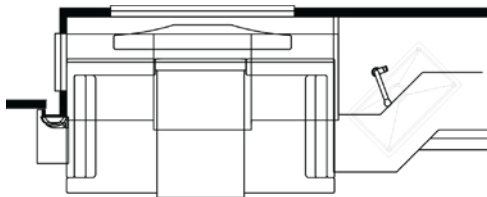

Theater Seating with Sleeper Booth

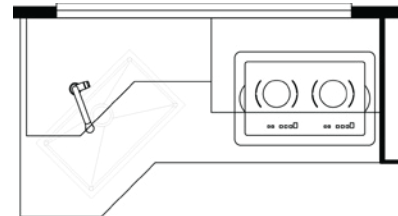

Kitchen Window

PERFECT FOR

- + Those Desiring High Maneuverability in a Class A Pusher
- + National Park Enthusiasts or Those Visiting Space Constrained Locations
- + Those Seeking Patio Views

Length	35' 10"	Interior Height	83"	Furnace	50,000 BTU
Width	101.5"	Grey Tank	75 gal.	Sleeps	2-6 People
App. Overall Height	12' 10"	Sewage Tank	55 gal.		
Interior Width	95.5"	Water Tank	105 gal.		

3809 FLOOR PLAN

STANDARD

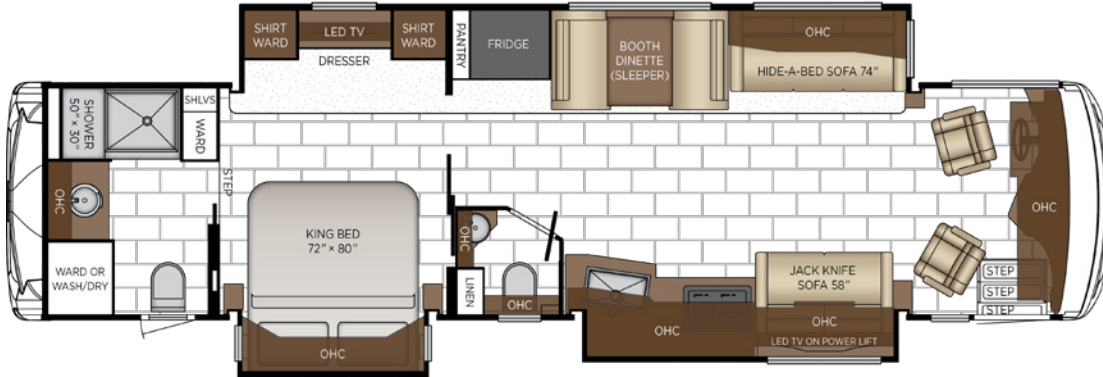

OPTIONS

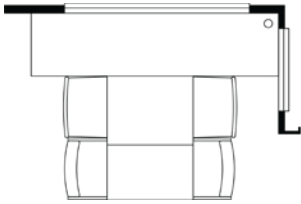

Combination Desk with Buffet Dinette

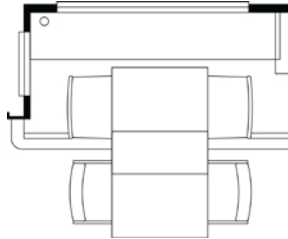

Combination Desk with Free Standing Dinette

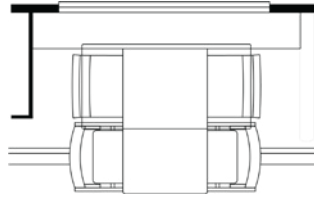

Convertible Dinette

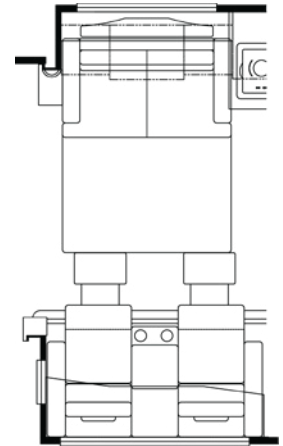

Theater Seating

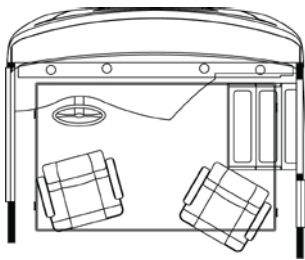

Drop Down Bunk

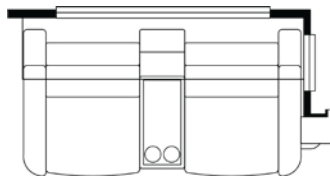

Euro Booth Dinette

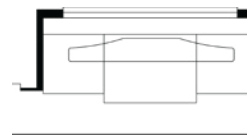

Fireplace Cabinet with TV Lift

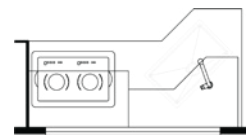

Kitchen Window

PERFECT FOR

- + Those Desiring High Maneuverability in a Class A Pusher
- + National Park Enthusiasts, Stadium Tailgaters, or Those Visiting Space Constrained Locations
- + Those Seeking Cozy Comforts

Length	38' 10"	Interior Height	83"	Furnace	50,000 BTU
Width	101.5"	Grey Tank	75 gal.	Sleeps	2-6 People
App. Overall Height	12' 10"	Sewage Tank	55 gal.		
Interior Width	95.5"	Water Tank	105 gal.		

4037 FLOOR PLAN

STANDARD

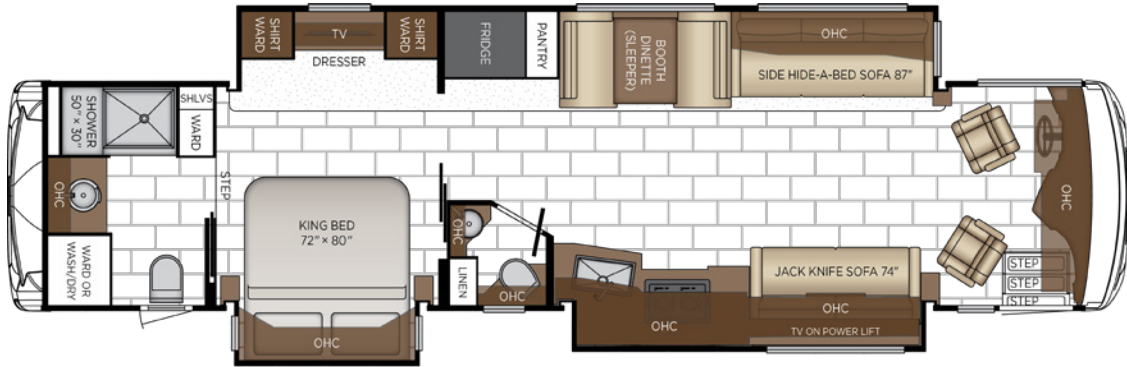

OPTIONS

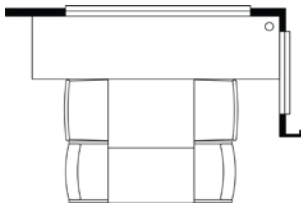

Combination Desk with Buffet Dinette

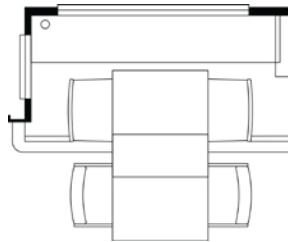

Combination Desk with Free Standing Dinette

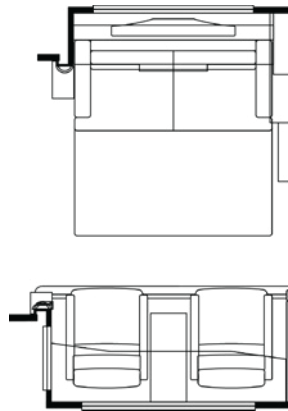

Two Recliners with Lamp Stand and Trifold Sofa

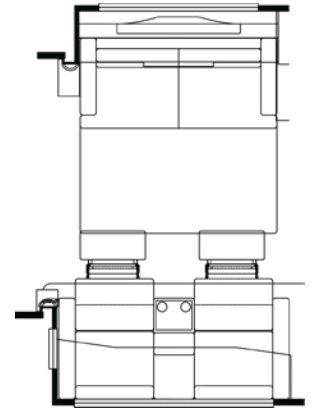

Theater Seating and Trifold Sofa

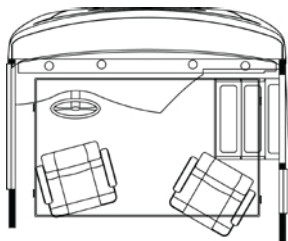

Drop Down Bunk

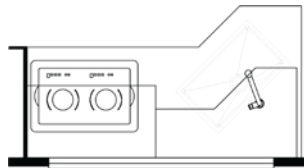

Kitchen Window

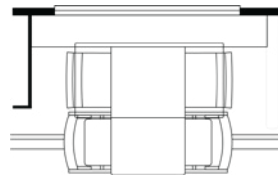

Convertible Dinette

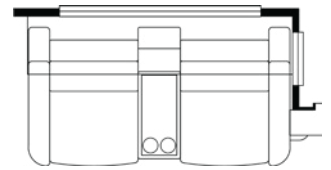

Euro Booth Dinette

PERFECT FOR

- + Couples Seeking a Spacious Retreat
- + Entertainers and Hosts Seeking Extra Space For Socializing

Length	40' 10"	Interior Height	83"	Furnace	50,000 BTU
Width	101.5"	Grey Tank	75 gal.	Sleeps	2-6 People
App. Overall Height	12' 11"	Sewage Tank	55 gal.		
Interior Width	95.5"	Water Tank	105 gal.		

4345 FLOOR PLAN *New Floorplan*

STANDARD

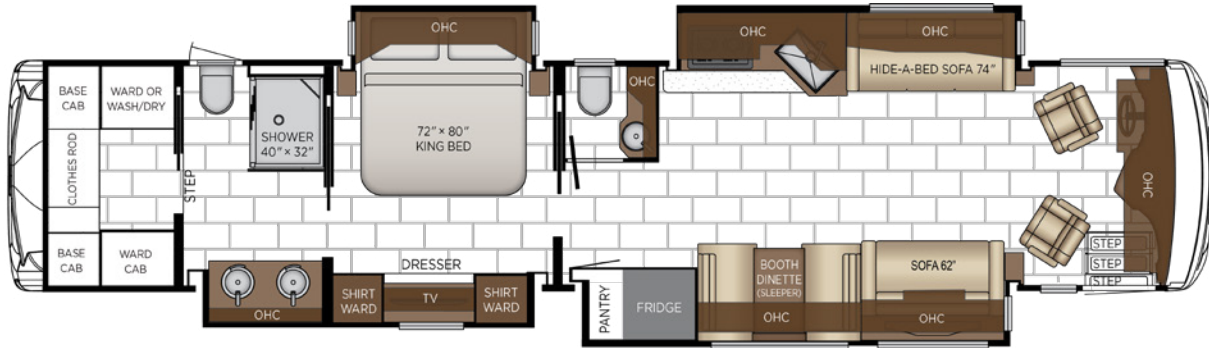

OPTIONS

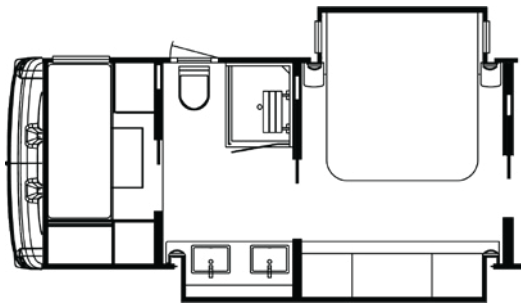

Bunk Beds in Rear Replaces Wardrobe, Washer and Dryer in Dresser with Retractable Bed Base

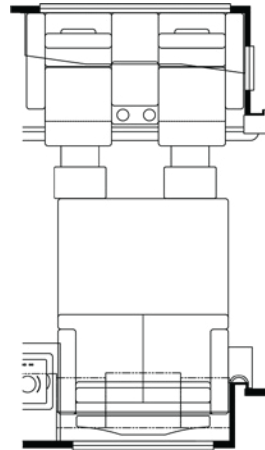

Theater Seating and Trifold Sofa

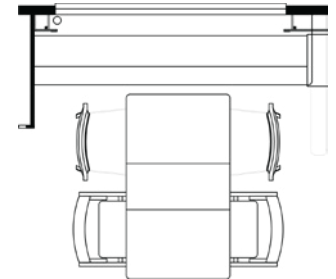

Buffet Dinette with Free Standing Table

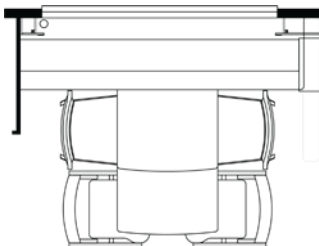

Combination Desk with Buffet Dinette

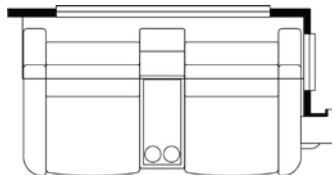

Euro Booth Dinette

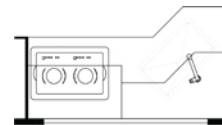

Kitchen Window

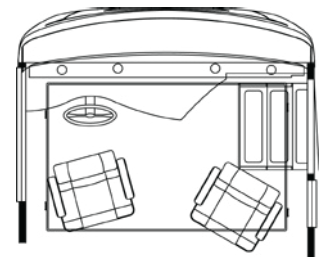

Drop Down Bunk

PERFECT FOR

- + Couples Seeking a Spacious Master Suite with Walk-In Closet
- + Families Who Prefer Bunk Beds At the Rear of the Coach
- + Hosts Seeking Midship Half Bath

Length	43' 10"	Interior Height	83"	Furnace	50,000 BTU
Width	101.5"	Grey Tank	75 gal.	Sleeps	2-7 People
App. Overall Height	13' 01"	Sewage Tank	55 gal.		
Interior Width	95.5"	Water Tank	105 gal.		

Our Best-Selling Ventana Floor Plan

4369 FLOOR PLAN

STANDARD

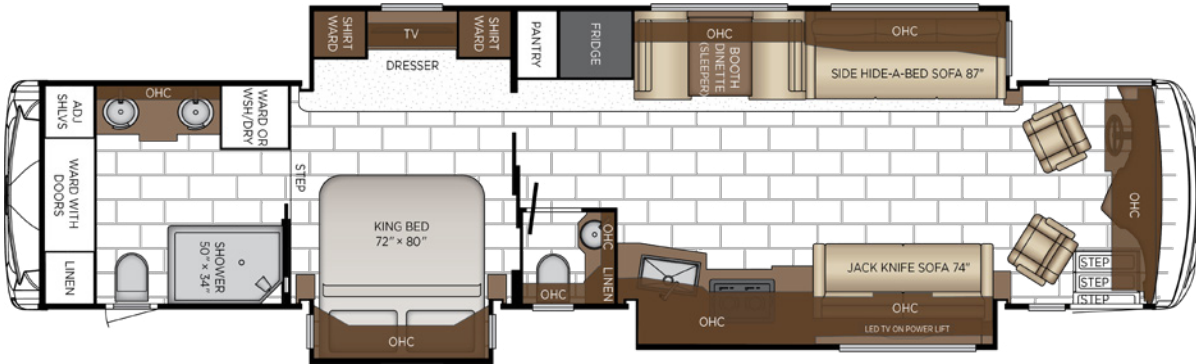

OPTIONS

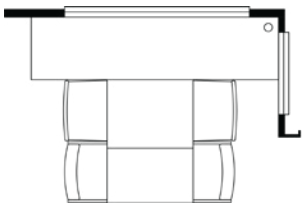

Combination Desk with Buffet Dinette

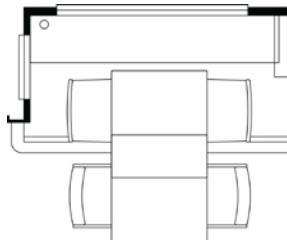

Combination Desk with Free Standing Dinette

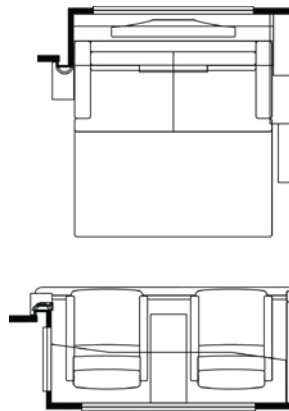

Two Recliners with Lamp Stand and Trifold Sofa

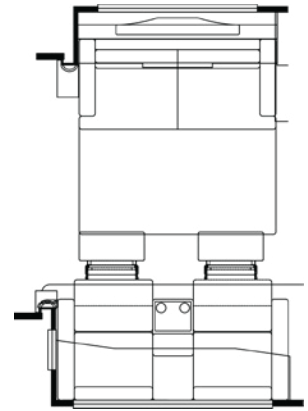

Theater Seating and Trifold Sofa

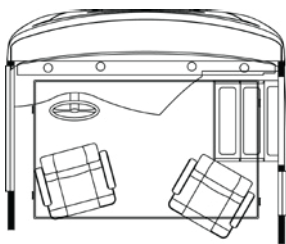

Drop Down Bunk

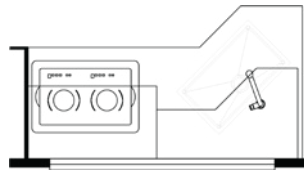

Kitchen Window

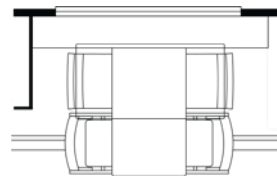

Convertible Dinette

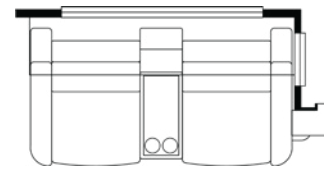

Euro Booth Dinette

PERFECT FOR

- + Aspiring Chefs Seeking Spacious Kitchens
- + Hosts Seeking Midship Half Bath

Length	43' 10"	Interior Height	83"	Furnace	50,000 btu
Width	101.5"	Grey Tank	75 gal.	Sleeps	2-6 People
App. Overall Height	13' 01"	Sewage Tank	55 gal.		
Interior Width	95.5"	Water Tank	105 gal.		

FLOOR PLAN SPECIFICATIONS

FLOOR PLAN KEY FEATURES

+ 3512:

- **Perfect For:** Those Desiring High Maneuverability in a Class A Pusher, National Park Enthusiasts or Those Visiting Space-Constrained Locations, Those Seeking Patio Views
- **Key Features:** Maximum Maneuverability, Patio-Side Dinette

+ 3809:

- **Perfect For:** Those Desiring High Maneuverability in a Class A Pusher, National Park Enthusiasts, Tailgaters, or Those Visiting Space Constrained Locations, Those Seeking Cozy Comforts
- **Key Features:** Maximum Maneuverability, Half Bath Midship, Fireplace (Optional), Robust Furniture Options and Entertainment Features

+ 4037:

- **Perfect For:** Couples Seeking a Spacious Retreat Entertainers and Hosts Seeking Extra Space For Socializing
- **Key Features:** Gourmet Kitchen, Multiple Dinette Options, Spacious King Bedroom, Midship Half Bath

+ 4340:

- **Perfect For:** Families, Those Working Those Working from the Road
- **Key Features:** Midship Bunks, Two Full Baths, King-Size Bedroom Suite

+ 4345:

- **Perfect For:** Couples Seeking Spacious Master Suite and Walk-In Closet, Families
- **Key Features:** Spacious Kitchen, Flexible Dining Options, Midship Half Bath, Luxurious King Bedroom

+ 4369:

- **Perfect For:** Aspiring Chefs Seeking Spacious Kitchens, Hosts Seeking Midship Half Bath
- **Key Features:** Best-Selling Ventana Floor Plan, Spacious Kitchen, Pull-Out Counter, Flexible Dining Options, Midship Half Bath, Luxurious King Bedroom

FLOOR PLAN SPECIFICATIONS

FLOOR PLAN	LENGTH	WIDTH	APP. OVERALL HEIGHT	INTERIOR WIDTH	INTERIOR HEIGHT	GREY TANK	SEWAGE TANK	WATER TANK	FURNACE	SLEEPS
3512	35' 10"	101.5"	12' 10"	95.5"	83"	75 gal.	55 gal.	105 gal.	50,000 BTU	2-6
3809	38' 10"	101.5"	12' 10"	95.5"	83"	75 gal.	55 gal.	105 gal.	50,000 BTU	2-6
4037	40' 10"	101.5"	12' 11"	95.5"	83"	75 gal.	55 gal.	105 gal.	50,000 BTU	2-6
4340	43' 10"	101.5"	13' 01"	95.5"	83"	75 gal.	55 gal.	105 gal.	50,000 BTU	2-5
4345	43' 10"	101.5"	13' 01"	95.5"	83"	75 gal.	55 gal.	105 gal.	50,000 BTU	2-7
4369	43' 10"	101.5"	13' 01"	95.5"	83"	75 gal.	55 gal.	105 gal.	50,000 BTU	2-6

The content in our literature depicts and describes products that are subject to change. For the most recent images and information, please visit NewmarCorp.com. Lengths, heights, widths, and dry weights are approximate. Weight will vary based on optional equipment added to the above base weight.

CHASSIS



CHASSIS

- + Freightliner Custom Chassis®, 380 HP
- + Freightliner Custom Chassis®, Tag Axle, 400 HP
- + Spartan®, 380 HP
- + Spartan®, Tag Axle, 400 HP
- + California Compliance Available

HORSE POWER

380-400^{HP}

Cummins B6.7 Diesel Engine

FUEL TANK

100^{GAL}

LENGTH

35-43^{FT}

TORQUE

1,150/
1,250^{LB/FT}

AXLES

2-3
Tag Axle Equipped
on all 40'+ Models

TIRE SIZE

22.5"

Michelin Brand
Front: 295/80R (35', 38' & 40') 16-Ply
Rear: 315/80R (43') 20-Ply

STEERING WHEEL

Comfort Drive™ Adaptive
Steering with Power
Column and Adjustable
Control

SAFETY

- + Electronic Stability Control
- + Automatic Traction Control
- + Collision Mitigation
- + Adaptive Cruise Control

TRANSMISSION

Allison 6-Speed 3000MH
Auto Transmission

CHASSIS SPECIFICATIONS

GLOSSARY

- + **GAWR:** Gross Axle Weight Rating is the maximum permissible weight for an axle.
- + **GVWR:** Gross Vehicle Weight Rating is the maximum permissible weight for a fully loaded motor coach.
- + **GCWR:** Gross Combination Weight Rating is the value specified by the manufacturer of the vehicle as the maximum allowable loaded weight of this motor coach and any towed trailer or towed vehicle.
- + **UVW:** Unloaded Vehicle Weight is the weight of this motor coach as built at the factory with full fuel, engine oil, and coolants. Does not include cargo, fresh water, propane gas, or dealer-installed accessories.
- + **NCC:** Net Carrying Capacity is the maximum weight of all occupants, including the driver, personal belongings, food, fresh water, waste water, propane gas, tools, tongue weight of towed vehicle, dealer-installed accessories, etc., that can be carried by the motor coach.
- + Specifications supplied by the chassis manufacturer.

SPARTAN® CHASSIS												
FLOOR PLAN	ENGINE HP	AXLE RATIO	FUEL CAP.	WHEEL BASE	TIRE SIZE	FRONT GAWR	REAR GAWR	TAG GAWR	GVWR	GCWR	APP. UVW	APP. NCC
3512	380	4.78	100	212	9"	14000 lb.	24000 lb.	0	38000 lb.	48000 lb.	31450 lb.	6550 lb.
3809	380	4.78	100	248	9"	14600 lb.	24000 lb.	0	38600 lb.	48600 lb.	32700 lb.	5900 lb.
4037	400	4.78	100	245+TAG	9"	14600 lb.	20000 lb.	10000 lb.	44600 lb.	59600 lb.	35400 lb.	9200 lb.
4340	400	4.78	100	281+TAG	9"	16000 lb.	20000 lb.	10000 lb.	46000 lb.	61000 lb.	37000 lb.	9000 lb.
4345	400	4.78	100	281+TAG	9"	16000 lb.	20000 lb.	10000 lb.	46000 lb.	61000 lb.	36900 lb.	9100 lb.
4369	400	4.78	100	281+TAG	9"	16000 lb.	20000 lb.	10000 lb.	46000 lb.	61000 lb.	36900 lb.	9100 lb.

FREIGHTLINER® CUSTOM CHASSIS												
FLOOR PLAN	ENGINE HP	AXLE RATIO	FUEL CAP.	WHEEL BASE	TIRE SIZE	FRONT GAWR	REAR GAWR	TAG GAWR	GVWR	GCWR	APP. UVW	APP. NCC
3512	380	4.78	100	212	9"	14200 lb.	24000 lb.	0	38200 lb.	48200 lb.	31500 lb.	6700 lb.
3809	380	4.78	100	248	9"	15000 lb.	24000 lb.	0	39000 lb.	49000 lb.	32950 lb.	6050 lb.
4037	400	4.78	100	245+TAG	9"	15000 lb.	20000 lb.	10000 lb.	45000 lb.	60000 lb.	35900 lb.	9100 lb.
4340	400	4.78	100	281+TAG	9"	15600 lb.	20000 lb.	10000 lb.	45600 lb.	60600 lb.	37400 lb.	8200 lb.
4345	400	4.78	100	281+TAG	9"	15600 lb.	20000 lb.	10000 lb.	45600 lb.	60600 lb.	36950 lb.	8650 lb.
4369	400	4.78	100	281+TAG	9"	15600 lb.	20000 lb.	10000 lb.	45600 lb.	60600 lb.	36900 lb.	9100 lb.

The content in our literature depicts and describes products that are subject to change. For the most recent images and information, please visit NewmarCorp.com. Lengths, heights, widths, and dry weights are approximate. Weight will vary based on optional equipment added to the above base weight.

STANDARD FEATURES & OPTIONS

EXTERIOR FEATURES

- Exterior Full-Paint Masterpiece Finish™ with Clearcoat and Cut and Buff
- Painted Power Baggage Door Locks, Keyless Entrance Door with Touchpad and Doorbell
- Entrance Door Assist Handle
- Chrome Exterior Mirrors
- Convex Exterior Mirrors with Defrost, Remote Control and Turn Signal Indicators
- Front Cap Diamond Shield Protection
- Hydraulic Smart-Level Leveling Jacks with Bluetooth Compatible Touchpad
- Mud Flaps
- Rear Hitch for Towing Car
- Stainless Steel Exterior Trim Pieces on Front Cap and Grill Area
- Rear Protective Tow Guard with Stainless Newmar Letters
- Undercoating

OPTIONS

- Chrome Power Baggage Door Locks
- Flag Pole Bracket
- Rear Ladder
- Non-Powered Storage Trays (Size and Placement are Floor Plan Specific)
- Windshield Temporary Protection - For Transport Only

CONSTRUCTION FEATURES

- 16" On-Center Aluminum Frame Sidewalls & Roof Construction
- Egress Door with Ladder System
- Fiberglass Roof and Integrated Gutter Rail
- Foam Insulation 5/8" Laminated in Sidewalls & Ceiling
- Gelcoated Fiberglass Exterior Sidewalls, Front & Rear Caps
- Polar Pak R19 Batten Insulation in Roof
- Slideout with Automatic Mechanical Lock Arms - Scissor Style

WINDOWS, AWNINGS, & VENTS

- Fan-Tastic® Vent with Hardwood Louver Cover in Kitchen
- Fan-Tastic® Vent with Rain Sensor in Kitchen & Bathroom
- Girard® G2000 Power Side Awning with Wind Sensor, Remote Control & LED Lights
- Skylight Above Shower
- Slideout Covers
- Frameless Double-Pane Tinted Safety-Glass Windows
- One-Piece Tinted Windshield

OPTIONS

- Bunk Windows (Floor Plan 4340)
- Carefree® Window Awning Package of Three, One-Bedroom, One-Off Door Side Living Room, One-Door Side Living Room
- Dual Girard® Nova Side Awnings
- Kitchen Window (Floor Plan Specific)

CHASSIS FEATURES

- Allison 6-Speed 300MH Auto Transmission
- Anti-Lock Braking System
- Back-Up Alarm
- Battery Disconnect for Chassis Battery
- Cockpit Seat Belts Latch Sensors
- Cockpit Seat Occupancy Sensors
- Comfort Drive™ Adaptive Steering with Power Column and Adjustable Control
- Cruise Control
- Freightliner® Custom Chassis Optiview Dash Panel (Freightliner Chassis)
- Glass Dash Instrument Panel
- Cummins® Acumen Module on Freightliner® Custom Chassis, 40' and 43'
- Recessed Fuel Fills, with Cross Over to Fill From Either Side
- Seat Belt Warning Indicator in Dash Display
- Manual Tilt/Telescope Steering Wheel with VIP Smart Wheel
- Nine Function Switch Pod Steering Wheel in Center on Spartan® Chassis
- Tire Pressures Monitoring on Chassis
- Valid Digital Glare Free Dash on Spartan® Chassis
- V-Ride Drive Axle Suspension - Freightliner®
- Aluminum Wheels

OPTIONS

- OnGuard™ Collision Mitigation Adaptive Cruise System with Adjustable Following Distance Control
- Freightliner® Custom Chassis, 380 HP, 35' and 38' Ventana, California Compliance
- Freightliner® Custom Chassis, Tag Axle, 400 HP, 40' and 43' Ventana, California Compliance
- Spartan®, 380 HP, 35' and 38' Ventana
- Spartan®, Tag Axle, 400 HP, 40' and 43' Ventana

AIR CONDITIONING & HEATING

- Two 15K BTU Air Heat Pump Air Conditioners
- Three 15K BTU Heat Pump Air Conditioners on 43' Floor Plans
- Chinook Dual Loop Heat with Continuous Hot Water
- Dash Heater and Air Conditioner
- Driver and Passenger Dash Overhead Ventilation System
- Wall Mounted Sensors for Heating and Air Conditioning

OPTIONS

- Electric Radiant Heat Installed Below Main Floor Tile

ELECTRICAL FEATURES

- Automatic Generator Start On Low Battery or Temperature Setting
- Battery Disconnect Switch for House Battery
- Cable TV Connection
- Dash Radio, Cameras and Monitors to Power Up From Both House Batteries and Ignition

STANDARD FEATURES & OPTIONS (CONTINUED)

- 50 Amp Electrical Service with Flexible Cord and Automatic Transfer Switch
- Emergency Engine Start Switch
- Engine Block Heater
- Exterior Security Light, One Installed on Door Side
- Eight 6V Batteries
- Interior Courtesy Lights
- 3000W Pure Sine Inverter
- Recessed LED Lights in Ceiling and Underneath Overhead Cabinets
- Lights in Exterior Storage Compartments
- Midship Side Turn Signals
- Multiplex Lighting Control System
- 10.1" Multiplex Monitor System in Center of Coach with Interior Lighting & HVAC Controls
- Newmar App
- 8.0 kW Cummins Onan® Diesel Quiet Series Generator
- Power Rewind Reel with 33' Cord (35'-38' Floor Plans)
- Power Rewind Reel with 50' Cord (40'-43' Floor Plans)
- Adjustable Dimmable Reading Lights at Head of Bed
- 110V Recept in Bed Overhead with Two Pass-Through Ports
- 110V/USB Recept at Head of Each Bunk Area (Floor Plan Specific)
- 12V Recept Auxiliary on Dashboard
- Slideout Switch Manually Operated Hold to Run
- 10W Solar Panel to Charge Chassis Battery
- Spare Fuses in Chassis Fuse Panel
- Spare Fuses in House Fuse Panel
- Transfer Switch with Surge Protector
- USB Outlet at Dash for Driver Use
- USB Outlet at Dinette and Bedroom Night Stand
- Wireless Charging Mat Built Into Dash for Driver Use
- Wireless Charging Mat Built Into Passenger Console

OPTIONS

- 640 AHR Lithionics® Lithium Ion Battery System with Two 3000W Pure Sine Inverters (UL Approved)
- 960 AHR Lithionics® Lithium Ion Battery System with Two 3000W Pure Sine Inverters (UL Approved)
- Four 120W Flexible Solar Panels on Roof
- Solar Prep with 6 Gauge Wire Ran From Roof to House Battery Compartment

PLUMBING & BATH FEATURES

- Aqua Miser® Shower System
- Auto Fill in Water Works Compartment
- Demand Water System
- Exterior Shower Located on Off-Door Side
- Power Reel for Water Hose
- Sewage Holding Tank Rinse

- Sentrel Acrylic Shower Walls with Glass Door
- Dometic® 321 China Bowl Or Macerator China Bowl Stool (Varies Per Floor Plan)
- Water Filter

OPTIONS

- Fold-Down Shower Seat
- Hot Water Line to Generator Area

INTERIOR FEATURES

- Fitted Bedspread and Accent Pillows
- ABS Color-Coordinated Dash Panel
- Decorative Wall Art
- Designer Feature Ceiling
- Interior Passage Inlaid Three Panel Design Doors
- Interior Assist Handle at Main Entry Door
- MCD Power Shades at Windshield and Manual Shades at Driver and Passenger Side Windows
- MCD Window Shades
- Power Stepwell Cover
- Removable Transport Pads for Under Slideout Rollers
- Tile Floor in Kitchen, Bathroom, Bedroom and Living Areas
- Wastebasket in Kitchen Base Under Sink
- Woven Material on Slideout Floors

OPTIONS

- Safe Located in Wardrobe
- Pet Package: Newmar-Branded Splash-Proof Water and Food Bowls, Exterior Leash Hook, and Retractable Pet Gate

CABINETS & FURNITURE

- Concealed Cabinet Door Hinges
- Extended Rotation Concealed Cabinet Door Hinges For Washer and Dryer
- Soft-Close Cabinet Drawers
- Dovetail Cabinetry Drawers with Full Extension Ball Bearing Guides
- Mesh Cell Phone Holder at Each Bunk Bed (Floor Plan 4340)
- Flush Cooktop Cover, Matching Countertop Material
- Super Polished Solid-Surface Countertop in Bathroom and Bedroom
- Super Polished Solid-Surface Countertop in Kitchen, Undermount Sink and Sink Covers
- Convertible Booth Dinette (Floor Plan Specific)
- Driver & Passenger Seats with Six-Way Power, Power-Lumbar and Footrest Lifts on Bed Top
- Plush Pillow Top Mattress
- Molded Silverware Divider Tray
- Push-to-Release Pantry Drawer Slides
- Pullout Pantry Shelves (See Floor Plans for Availability)
- Ultrafabric Sofa and Front Seats
- Villa Comfort Fit Furniture

STANDARD FEATURES & OPTIONS (CONTINUED)

OPTIONS
<input type="checkbox"/> Drop-Down Bunk Bed Over Driver/Passenger Seats with Bunk Ladder
<input type="checkbox"/> Bunk Beds to Convert to Wardrobe (Floor Plan 4340)
<input type="checkbox"/> Combo Desk Dinette with Buffet Table, Two Fixed and Two Folding Chairs (Excludes Floor Plan 3512)
<input type="checkbox"/> Combo Desk Dinette with Free Standing Hide-A-Leaf Table, Two Fixed and Two Folding Chairs (Excludes Floor Plan 3512)
<input type="checkbox"/> Convertible Dinette with Two Fixed and Two Folding Chairs That Face to Window or Fore/Aft Seating (Excludes Floor Plan 3512)
<input type="checkbox"/> Euro Booth Dinette with Two Table Leaves, Removable Table Leg and Two Folding Chairs
<input type="checkbox"/> Air Mattress with Remote
<input type="checkbox"/> Two Recliners with Reading Lights and Lampstand Off Door Side, Trifold Sofa Door Side (1 Large Window)
<input type="checkbox"/> 74" Powered Theater Seating Replaces Hide-A-Bed Sofa Off Door Side, 58" Trifold Sofa Replaces Jackknife Sofa Door Side (Floor Plan 3809)
<input type="checkbox"/> 84" Powered Theater Seating Replaces Hide-A-Bed Sofa (Floor Plan 4340)
<input type="checkbox"/> 84" Powered Theater Seating with Reading Lights on Off-Door Side, 35" Booth Dinette Replaces 38" Booth Dinette on Door Side (Floor Plan 3512)
<input type="checkbox"/> Desk and Chair Replaces Midship Bunks to Create Workspace (Floor Plan 4340)
<input type="checkbox"/> Bunk Beds Replace Rear Wardrobe (Floor Plan 4345)
<input type="checkbox"/> 87" Powered Theatre Seating Replaces Side Hide-A-Bed on Off-Door Side, Trifold Sofa Replaces Jackknife Sofa on Door Side (Floor Plans 4037 and 4369)

APPLIANCES & ACCESSORIES

Air Horns
All-Electric Flush Mount Induction Cooktop
Fireplace in Living Area (Floor Plan 3809)
30" Stainless Steel Microwave Convection with Air Fryer Feature
19.7 Cu. Ft. Whirlpool® Refrigerator (35' - 38' Floor Plans)
22 Cu. Ft. Samsung® Refrigerator with Matching Microwave (40'+ Floor Plans)
Washer and Dryer Prep

OPTIONS
<input type="checkbox"/> Central Vacuum with Tool Kit
<input type="checkbox"/> Dishwasher in a Drawer with Stainless Steel Front Located Below Cooktop
<input type="checkbox"/> Freezer Electrical Prep (110V and 12V) Without Tray
<input type="checkbox"/> LP Cooktop, 22 Gallon LP Tank, Six 6V Batteries
<input type="checkbox"/> Stacked Two-Piece Splendide® Washer and Dryer

AUDIO, VIDEO & ACCESSORIES

Dash Radio with 180W Harman/JBL Sound System and Subwoofer
10 BC Fire Extinguisher, Carbon Monoxide, Smoke Detectors

High Definition Component Wiring
Bluetooth Microphone for Dash Radio
Rear View Color Monitor System with Audio
Satellite Dish Prep on Roof
Bose® Sound System Soundbar
TV Jack and 110V Recept in Door Side Exterior Storage Compartment
Samsung® 4K LED TVs in Living and Bedroom Areas (TV Sizes Vary Per Floor Plan)
Starlink Internet System (Subscription Required)
50" Samsung® 4K LED TV on Televator in Living Area
Xite Dash Radio with Apple CarPlay®, 9" Dual Monitors with Nav-N-Go Navigation System
Xite HD 360 Camera System with Grid Lines and Tri-View Rear Camera

OPTIONS
<input type="checkbox"/> Exterior Entertainment Center in Sidewall with 43" Samsung® 4K LED TV and Bose® Soundbar
<input type="checkbox"/> Extra Monitor on Passenger Side
<input type="checkbox"/> Radio SiriusXM® Capability with Antenna (Subscription Required)
<input type="checkbox"/> Satellite Prep Ground Tripod Dish on ODS with A/B Switch
<input type="checkbox"/> Starlink High-Performance Internet System
<input type="checkbox"/> 43" Samsung® 4K LED TV in Front Overhead
<input type="checkbox"/> Two 19" Skyworth TV/DVD Monitors - One at Each Standard Bunk (Floor Plan Specific)
<input type="checkbox"/> Universal Remote Control
<input type="checkbox"/> Universal Toll Module
<input type="checkbox"/> WiFiRanger Everest with Aspen Interior Router
<input type="checkbox"/> Winegard® Rayzar Automatic Digital TV Antenna

OUR PARTNERS

THE NEWMAR DIFFERENCE™

The Newmar Difference™ begins with suppliers dedicated to providing our customers with unrivaled quality, comfort, and support. We only work with suppliers that are dedicated to providing our customers with unrivaled innovation, comfort, and reliability. It's all so you can experience best-in-class performance from names you can trust. At Newmar, that's our difference, and our promise.



BASF

The Coatings division of BASF is a global expert in the development and production of innovative and sustainable OEM and refinish coatings. Coatings by BASF—solutions beyond your imagination.



Freightliner® Custom Chassis

Freightliner® Custom Chassis are renowned for their exceptional ride, excellent maneuverability, advanced technology, and nationwide 24/7 factory-direct support.



Spartan® RV Chassis

An American company with over 40 years of experience in designing and manufacturing the premier motorhome chassis, Spartan® delivers superior performance, exceptional safety ratings, and industry-leading technology.



Industrial Finishes

Industrial Finishes has supported RV manufacturers for over four decades, offering paint products that deliver uncompromising quality and provide your coach with a true Masterpiece™ finish.



RiverPark

From Samsung® 4K TVs and Xite Infotainment systems to Bose® soundbars and JBL and Infinity premium audio systems, RiverPark helps ensure you enjoy the ultimate audio-visual technology in your Newmar coach.

THE NEWMAR CUSTOMER EXPERIENCE

The Newmar Difference™ goes beyond our industry-leading motor coaches to provide you with an unrivaled ownership experience.



Crafted with Purpose

Every Newmar is crafted one at a time by folks who have spent an average of eight years building them. Each coach we assemble must undergo more than 1,000 tests and checks before ever leaving our factory.



The Highest Standards

We view our dealership network in terms of quality, not quantity. Each of our dealers acts as a partner in our shared mission to exceed your highest of expectations, for an ownership experience that's second to none from day one.



Built Around You

As a Newmar owner, you'll find resources specific to your coach through Newgle, an easy-to-use knowledge base that houses everything from user guides to technical support documents.



More Than a Number

Meet fellow owners through the Newmar Kountry Klub, a top social club for RV travelers that hosts rallies and other special events throughout the U.S. and Canada.



Seamless Service

When you join the Newmar family, we pair you with a dedicated service specialist with expert knowledge of your exact coach. Our service specialists guarantee dealer warranty authorizations within four business hours and ship all in-stock parts the same day, free of charge.



Without Compromise

All models include a one-year/unlimited mileage limited warranty and a five-year, non-transferable structural warranty that covers your coach's superstructure in the event it fails to perform. Ask your Newmar dealer for more details.

CONTACT

Newmar Corporation
1952 Cheyenne St.
Nappanee, IN 46550

+ Phone: 574-773-7791
+ Fax: 574-773-2895
+ NewmarCorp.com

